

NATIONAL ELECTRONICS

READOUT TUBES

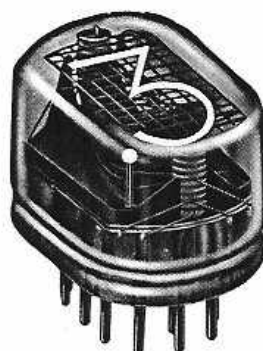
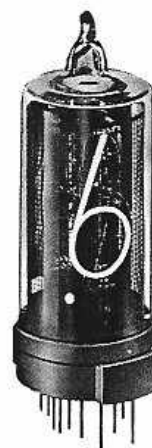

NATIONAL

*READOUT TUBES BY NATIONAL ELECTRONICS

NATIONAL[®] READOUT TUBES are simple neon filled cold cathode discharge tubes. Each tube consists of a common anode and 10 independent cathodes, each formed in the shape of a numeral. Application of a negative voltage to a selected cathode causes the gas around the cathode to ionize and glow. The visual effect is a bright red orange neon glow closely following the shape of the energized cathode.

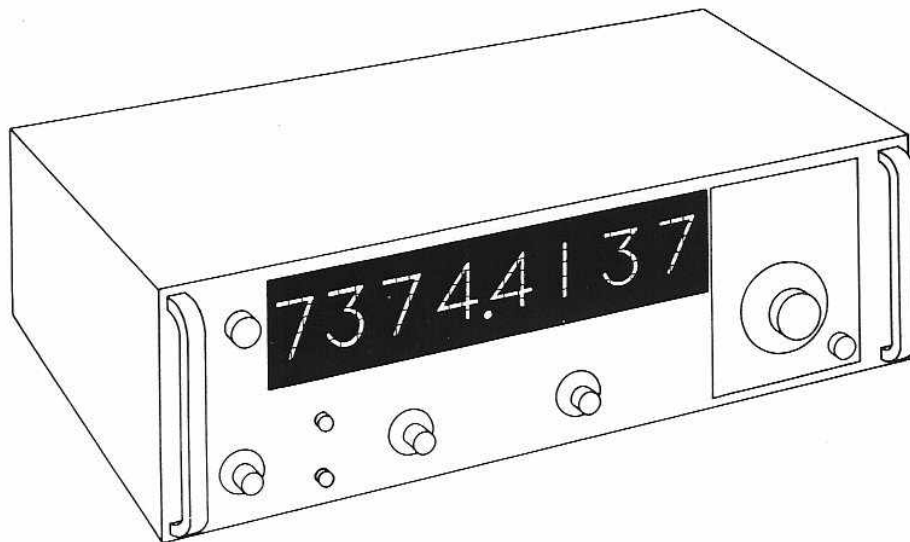

NATIONAL[®] READOUT TUBES — electronic display devices that are
RUGGED — longest life of any Readout; shock and vibration meet
military requirements.

ATTRACTIVE — well shaped characters, bright even color.



**NATIONAL
ELECTRONICS**

GENEVA, ILLINOIS 60134
A RICHARDSON COMPANY

SELECTION GUIDE

NATIONAL ELECTRONICS READOUT TUBES



MINIATURE

(.310" CHARACTER SIZE)
END VIEWING
14' VIEWING DISTANCE



NL4998
LONG LIFE

NL7977/4032
LONG LIFE

NL7009
STANDARD LIFE



½" CHARACTER SIZE
SIDE VIEWING
25' VIEWING DISTANCE

NL5870S
LONG LIFE

NL5870ST
LONG LIFE

NL5560/918
LONG LIFE

STANDARD

(.610" CHARACTER SIZE)
SIDE VIEWING
30' VIEWING DISTANCE



NL5440
LONG LIFE

NL5440A
LONG LIFE

NL8754/840
LONG LIFE

NL900
LONG LIFE

NL904
LONG LIFE

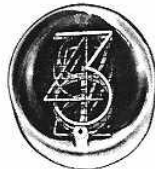

STANDARD AND SUPER

(.610 CHARACTER SIZE) (.808 CHARACTER SIZE)

SIDE END VIEWING
30' AND 38' VIEWING DISTANCE

NL8421/5092
LONG LIFE
.610 CHARACTER SIZE

NL8422/5991
LONG LIFE
RECTANGULAR
.610 CHARACTER SIZE

NL809
LONG LIFE
RECTANGULAR
WITH DECIMAL POINT
.610 CHARACTER SIZE

NL8423/6091
LONG LIFE
.808 CHARACTER SIZE

NL807
SIDE VIEWING
LONG LIFE
.808 CHARACTER SIZE

LARGE AND JUMBO

(1.375" CHARACTER SIZE) (2.0" CHARACTER SIZE)

SIDE AND END VIEWING
65' AND 100' VIEWING DISTANCE

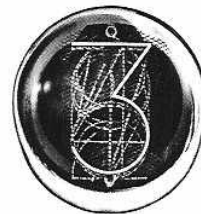

NL8091
LONG LIFE
1.375 CHARACTER SIZE

NL7094
LONG LIFE
2.0 CHARACTER SIZE

NL7037
LONG LIFE
SIDE VIEWING
2.0 CHARACTER SIZE

*Multiple type numbers are always the EIA assigned number followed by the common industry number.

TECHNICAL DATA NATIONAL

NUMERALS 0 thru 9	NL-4998	NL-7977/4032	NL-4021, NL-4021AL• NL-7009	NL-5961•• NL-8422/5991																																																																																																																																														
SYMBOLS + and -		NL-4031	NL-4026	NL-5992																																																																																																																																														
LT HAND DECIMAL																																																																																																																																																		
SPECIAL CHARACTER			NL-4038	NL-806																																																																																																																																														
CHARACTER SIZE (INCHES)	.310	.310	.310	.610																																																																																																																																														
VIEWING DISTANCE (FEET)	14	14	14	30																																																																																																																																														
ELECTRICAL RATINGS AND CHARACTERISTICS			NL-4038 NL-4021 NL-7009 NL-4021AL NL-4026	NL5961 ONLY																																																																																																																																														
Ionization Voltage (Maximum)	170 Vdc	170 Vdc	170 Vdc	170 Vdc																																																																																																																																														
Supply Voltage (Minimum)	170 Vdc	170 Vdc	120Vdc††	170 Vdc																																																																																																																																														
Cathode Current — Peak (Max.)	2.5 mA	2.0 mA	2.0 mA	3.5 mA																																																																																																																																														
Average (Max.)	2.0 mA	1.4 mA	2.0 mA	4.5 mA																																																																																																																																														
Average (Min.)	1.2 mA	0.7 mA	1.2 mA 1.4 mA	3.0 mA 3.3 mA																																																																																																																																														
			0.7 mA 0.7 mA	1.5 mA 1.8 mA																																																																																																																																														
dc Prebias Voltage Limits...	65 Vdc to 120 Vdc	50 Vdc to 120 Vdc	50 Vdc to 75 Vdc	50 Vdc to 120 Vdc																																																																																																																																														
**Recommended Operating Conditions dc Supply Voltage (Ebb)	170Vdc 250Vdc 300Vdc	170Vdc 250Vdc 300Vdc	170Vdc 250Vdc 300Vdc	170Vdc 250Vdc 300Vdc																																																																																																																																														
Corresponding Anode Resistor (Rp)	15K 75K 110K	15K 91K 150K	68K 150K 200K	8.2K 39K 56K																																																																																																																																														
Temperature Limits (Reduced Life)	-20 °C to +55 °C -40 °C to +70 °C	-20 °C to +55 °C -40 °C to +70 °C	-20 °C to +55 °C -40 °C to +70 °C	-20 °C to +55 °C -40 °C to +70 °C																																																																																																																																														
Weight	0.14 oz.	0.14 oz.	0.14 oz.	0.3 oz.																																																																																																																																														
OUTLINE DRAWINGS																																																																																																																																																		
Socket (See Page 12)	C.F.	RTS-3		RTS-4, RTS-10																																																																																																																																														
Mounting Position	PINS 6 & 12 VERTICALLY ALIGNED WITH PIN 6 ON TOP	PINS 1 & 7 VERTICALLY ALIGNED WITH PIN 7 ON TOP		PINS 6 & 12 VERTICALLY ALIGNED WITH PIN 6 ON TOP																																																																																																																																														
PIN CONNECTIONS	<table border="1" style="font-size: small;"> <tr><th>PIN NUMBER</th><th>CHARACTER</th></tr> <tr><td>1</td><td>2</td></tr> <tr><td>2</td><td>3</td></tr> <tr><td>3</td><td>4</td></tr> <tr><td>4</td><td>5</td></tr> <tr><td>5</td><td>6</td></tr> <tr><td>6</td><td>Internal Conn.</td></tr> <tr><td>7</td><td>7</td></tr> <tr><td>8</td><td>8</td></tr> <tr><td>9</td><td>9</td></tr> <tr><td>10</td><td>0</td></tr> <tr><td>11</td><td>Anode</td></tr> <tr><td>12</td><td>1</td></tr> <tr><td>13</td><td>Internal Conn.</td></tr> </table>	PIN NUMBER	CHARACTER	1	2	2	3	3	4	4	5	5	6	6	Internal Conn.	7	7	8	8	9	9	10	0	11	Anode	12	1	13	Internal Conn.	<table border="1" style="font-size: small;"> <tr><th>PIN NUMBER</th><th>CHARACTER</th></tr> <tr><td>1</td><td>1</td></tr> <tr><td>2</td><td>2</td></tr> <tr><td>3</td><td>3</td></tr> <tr><td>4</td><td>4</td></tr> <tr><td>5</td><td>5</td></tr> <tr><td>6</td><td>6</td></tr> <tr><td>7</td><td>7</td></tr> <tr><td>8</td><td>8</td></tr> <tr><td>9</td><td>9</td></tr> <tr><td>10</td><td>0</td></tr> <tr><td>11</td><td>Anode</td></tr> </table>	PIN NUMBER	CHARACTER	1	1	2	2	3	3	4	4	5	5	6	6	7	7	8	8	9	9	10	0	11	Anode	<table border="1" style="font-size: small;"> <tr><th>PIN NUMBER</th><th>CHARACTER</th></tr> <tr><td>1</td><td>4031 ONLY I.C.</td></tr> <tr><td>2</td><td>4038 ONLY I.C.</td></tr> <tr><td>3</td><td>L</td></tr> <tr><td>4</td><td>E</td></tr> <tr><td>5</td><td>A</td></tr> <tr><td>6</td><td>Plus</td></tr> <tr><td>7</td><td>H</td></tr> <tr><td>8</td><td>G</td></tr> <tr><td>9</td><td>K</td></tr> <tr><td>10</td><td>Minus</td></tr> <tr><td>11</td><td>M</td></tr> <tr><td>12</td><td>J</td></tr> <tr><td>13</td><td>Anode</td></tr> <tr><td>14</td><td>Anode</td></tr> </table>	PIN NUMBER	CHARACTER	1	4031 ONLY I.C.	2	4038 ONLY I.C.	3	L	4	E	5	A	6	Plus	7	H	8	G	9	K	10	Minus	11	M	12	J	13	Anode	14	Anode	<table border="1" style="font-size: small;"> <tr><th>PIN NUMBER</th><th>CHARACTER</th><th>NL-5992 ONLY</th><th>806 ONLY</th></tr> <tr><td>1</td><td>Anode</td><td>—</td><td>—</td></tr> <tr><td>2</td><td>0</td><td>—</td><td>—</td></tr> <tr><td>3</td><td>9</td><td>—</td><td>—</td></tr> <tr><td>4</td><td>8</td><td>—</td><td>—</td></tr> <tr><td>5</td><td>7</td><td>Plus</td><td>Plus</td></tr> <tr><td>6</td><td>6</td><td>—</td><td>—</td></tr> <tr><td>7</td><td>5</td><td>—</td><td>—</td></tr> <tr><td>8</td><td>4</td><td>Minus</td><td>Minus</td></tr> <tr><td>9</td><td>3</td><td>—</td><td>—</td></tr> <tr><td>10</td><td>2</td><td>—</td><td>—</td></tr> <tr><td>11</td><td>1</td><td>I.C.</td><td>I.C.</td></tr> <tr><td>12</td><td>I.C.</td><td>I.C.</td><td>I.C.</td></tr> <tr><td>13</td><td>I.C.</td><td>I.C.</td><td>I.C.</td></tr> <tr><td>14</td><td>I.C.</td><td>I.C.</td><td>I.C.</td></tr> </table>	PIN NUMBER	CHARACTER	NL-5992 ONLY	806 ONLY	1	Anode	—	—	2	0	—	—	3	9	—	—	4	8	—	—	5	7	Plus	Plus	6	6	—	—	7	5	—	—	8	4	Minus	Minus	9	3	—	—	10	2	—	—	11	1	I.C.	I.C.	12	I.C.	I.C.	I.C.	13	I.C.	I.C.	I.C.	14	I.C.	I.C.	I.C.
PIN NUMBER	CHARACTER																																																																																																																																																	
1	2																																																																																																																																																	
2	3																																																																																																																																																	
3	4																																																																																																																																																	
4	5																																																																																																																																																	
5	6																																																																																																																																																	
6	Internal Conn.																																																																																																																																																	
7	7																																																																																																																																																	
8	8																																																																																																																																																	
9	9																																																																																																																																																	
10	0																																																																																																																																																	
11	Anode																																																																																																																																																	
12	1																																																																																																																																																	
13	Internal Conn.																																																																																																																																																	
PIN NUMBER	CHARACTER																																																																																																																																																	
1	1																																																																																																																																																	
2	2																																																																																																																																																	
3	3																																																																																																																																																	
4	4																																																																																																																																																	
5	5																																																																																																																																																	
6	6																																																																																																																																																	
7	7																																																																																																																																																	
8	8																																																																																																																																																	
9	9																																																																																																																																																	
10	0																																																																																																																																																	
11	Anode																																																																																																																																																	
PIN NUMBER	CHARACTER																																																																																																																																																	
1	4031 ONLY I.C.																																																																																																																																																	
2	4038 ONLY I.C.																																																																																																																																																	
3	L																																																																																																																																																	
4	E																																																																																																																																																	
5	A																																																																																																																																																	
6	Plus																																																																																																																																																	
7	H																																																																																																																																																	
8	G																																																																																																																																																	
9	K																																																																																																																																																	
10	Minus																																																																																																																																																	
11	M																																																																																																																																																	
12	J																																																																																																																																																	
13	Anode																																																																																																																																																	
14	Anode																																																																																																																																																	
PIN NUMBER	CHARACTER	NL-5992 ONLY	806 ONLY																																																																																																																																															
1	Anode	—	—																																																																																																																																															
2	0	—	—																																																																																																																																															
3	9	—	—																																																																																																																																															
4	8	—	—																																																																																																																																															
5	7	Plus	Plus																																																																																																																																															
6	6	—	—																																																																																																																																															
7	5	—	—																																																																																																																																															
8	4	Minus	Minus																																																																																																																																															
9	3	—	—																																																																																																																																															
10	2	—	—																																																																																																																																															
11	1	I.C.	I.C.																																																																																																																																															
12	I.C.	I.C.	I.C.																																																																																																																																															
13	I.C.	I.C.	I.C.																																																																																																																																															
14	I.C.	I.C.	I.C.																																																																																																																																															

*Other characters available by special order.

**See Fig. 1 & 3, Page 9. Use of the highest voltage available with the appropriate resistor is recommended.

††Corresponding anode resistor (Rp) is 20K.

ELECTRONICS READOUT TUBES

	NL-6844A●● NL-8037/5031	NL-8421/5092	NL-8423/6091 NL-7153●●	NL-8091	NL-7094																																																																																																																																																																																																												
	NL-5016●● NL-5032	NL-50911	NL-6034	NL-887	NL-825																																																																																																																																																																																																												
NL-809																																																																																																																																																																																																																	
.610	.610	.610	.808	1.375	2																																																																																																																																																																																																												
30	30	30	38	65	100																																																																																																																																																																																																												
170 Vdc 170 Vdc 3.5 mA †3.0 mA †1.5 mA	NL-6844A NL-8037 NL-5016 NL-5032 170 Vdc 170 Vdc 170 Vdc 170 Vdc 4.0 mA 3.5 mA 3.0 mA 3.0 mA 1.5 mA 1.5 mA	170 Vdc 170 Vdc 3.5 mA 3.0 mA 1.5 mA	170 Vdc 170 Vdc 4.5 mA 4.0 mA 1.5 mA	170 Vdc 170 Vdc 6.5 mA 6.0 mA 3.0 mA	170 Vdc 170 Vdc 7.5 mA 7.0 mA 4.0 mA																																																																																																																																																																																																												
50 Vdc to 120 Vdc	50 Vdc to 120 Vdc	50 Vdc to 120 Vdc	65 Vdc to 120 Vdc	65 Vdc to 120 Vdc	65 Vdc to 120 Vdc																																																																																																																																																																																																												
70Vdc 250Vdc 300Vdc 8.2K 39K 56K	170Vdc 250Vdc 300Vdc 15K 51K 75K	170Vdc 250Vdc 300Vdc 10K 47K 68K	170Vdc 250Vdc 300Vdc 6.8K 27K 43K	170Vdc 250Vdc 300Vdc 5.6K 22K 33K	200Vdc 250Vdc 300Vdc 9.1K 16K 24K																																																																																																																																																																																																												
-20°C to +55°C -40°C to +70°C 0.3 oz.	-65°C to +85°C 0.4 oz.	-20°C to +55°C -40°C to +70°C 0.4 oz.	-20°C to +55°C -40°C to +70°C 0.6 oz.	-20°C to +55°C -40°C to +70°C 1.7 oz.	-20°C to +55°C -40°C to +70°C 4 oz.																																																																																																																																																																																																												
RTS-4, RTS-10	RTS-1, RTS-2 RTS-6			RTS-5	RTS-5																																																																																																																																																																																																												
INS 6 & 12 VERTICALLY ALIGNED WITH PIN 6 ON TOP	PINS 1-8 VERTICALLY ALIGNED WITH PIN 8 ON TOP			PINS 1 & 10 VERTICALLY ALIGNED WITH PIN 10 ON TOP																																																																																																																																																																																																													
<table border="1"> <thead> <tr> <th>PIN NUMBER</th> <th>CHARACTER</th> </tr> </thead> <tbody> <tr><td>1</td><td>Anode</td></tr> <tr><td>2</td><td>0</td></tr> <tr><td>3</td><td>8</td></tr> <tr><td>4</td><td>9</td></tr> <tr><td>5</td><td>6</td></tr> <tr><td>6</td><td>5</td></tr> <tr><td>7</td><td>4</td></tr> <tr><td>8</td><td>3</td></tr> <tr><td>9</td><td>2</td></tr> <tr><td>10</td><td>1</td></tr> <tr><td>11</td><td>Decimal Pt.</td></tr> <tr><td>12</td><td>Internal Conn.</td></tr> <tr><td>13</td><td>Internal Conn.</td></tr> <tr><td>14</td><td>Internal Conn.</td></tr> </tbody> </table>	PIN NUMBER	CHARACTER	1	Anode	2	0	3	8	4	9	5	6	6	5	7	4	8	3	9	2	10	1	11	Decimal Pt.	12	Internal Conn.	13	Internal Conn.	14	Internal Conn.	<table border="1"> <thead> <tr> <th>PIN NUMBER</th> <th>CHARACTER</th> <th>NL-6034</th> <th>NL-5032</th> <th>NL-5016</th> <th>NL-50911 ONLY</th> </tr> </thead> <tbody> <tr><td>1</td><td>Internal Conn.</td><td>—</td><td>—</td><td>—</td><td>—</td></tr> <tr><td>2</td><td>Anode</td><td>—</td><td>—</td><td>—</td><td>—</td></tr> <tr><td>3</td><td>0</td><td>—</td><td>—</td><td>—</td><td>—</td></tr> <tr><td>4</td><td>8</td><td>—</td><td>—</td><td>—</td><td>—</td></tr> <tr><td>5</td><td>9</td><td>—</td><td>—</td><td>—</td><td>—</td></tr> <tr><td>6</td><td>6</td><td>—</td><td>—</td><td>—</td><td>—</td></tr> <tr><td>7</td><td>5</td><td>—</td><td>—</td><td>—</td><td>—</td></tr> <tr><td>8</td><td>4</td><td>—</td><td>—</td><td>—</td><td>—</td></tr> <tr><td>9</td><td>3</td><td>—</td><td>—</td><td>—</td><td>—</td></tr> <tr><td>10</td><td>2</td><td>—</td><td>—</td><td>—</td><td>—</td></tr> <tr><td>11</td><td>3</td><td>—</td><td>—</td><td>—</td><td>—</td></tr> <tr><td>12</td><td>2</td><td>—</td><td>—</td><td>—</td><td>—</td></tr> <tr><td>13</td><td>1</td><td>—</td><td>—</td><td>—</td><td>—</td></tr> </tbody> </table>			PIN NUMBER	CHARACTER	NL-6034	NL-5032	NL-5016	NL-50911 ONLY	1	Internal Conn.	—	—	—	—	2	Anode	—	—	—	—	3	0	—	—	—	—	4	8	—	—	—	—	5	9	—	—	—	—	6	6	—	—	—	—	7	5	—	—	—	—	8	4	—	—	—	—	9	3	—	—	—	—	10	2	—	—	—	—	11	3	—	—	—	—	12	2	—	—	—	—	13	1	—	—	—	—	<table border="1"> <thead> <tr> <th>PIN NUMBER</th> <th>NL-8091</th> <th>NL-7094</th> <th>NL-887 ONLY</th> <th>NL-825 ONLY</th> </tr> </thead> <tbody> <tr><td>1</td><td>Internal Conn.</td><td>—</td><td>—</td><td>—</td></tr> <tr><td>2</td><td>Anode</td><td>—</td><td>—</td><td>—</td></tr> <tr><td>3</td><td>0</td><td>—</td><td>—</td><td>—</td></tr> <tr><td>4</td><td>8</td><td>—</td><td>—</td><td>—</td></tr> <tr><td>5</td><td>9</td><td>—</td><td>—</td><td>—</td></tr> <tr><td>6</td><td>Internal Conn.</td><td>—</td><td>—</td><td>—</td></tr> <tr><td>7</td><td>6</td><td>—</td><td>—</td><td>—</td></tr> <tr><td>8</td><td>5</td><td>—</td><td>—</td><td>—</td></tr> <tr><td>9</td><td>4</td><td>—</td><td>—</td><td>—</td></tr> <tr><td>10</td><td>3</td><td>—</td><td>—</td><td>—</td></tr> <tr><td>11</td><td>2</td><td>—</td><td>—</td><td>—</td></tr> <tr><td>12</td><td>1</td><td>—</td><td>—</td><td>—</td></tr> <tr><td>13</td><td>Internal Conn.</td><td>—</td><td>—</td><td>—</td></tr> <tr><td>14</td><td>Internal Conn.</td><td>—</td><td>—</td><td>—</td></tr> <tr><td>15</td><td>Internal Conn.</td><td>—</td><td>—</td><td>—</td></tr> <tr><td>16</td><td>2</td><td>—</td><td>—</td><td>—</td></tr> <tr><td>17</td><td>1</td><td>—</td><td>—</td><td>—</td></tr> </tbody> </table>		PIN NUMBER	NL-8091	NL-7094	NL-887 ONLY	NL-825 ONLY	1	Internal Conn.	—	—	—	2	Anode	—	—	—	3	0	—	—	—	4	8	—	—	—	5	9	—	—	—	6	Internal Conn.	—	—	—	7	6	—	—	—	8	5	—	—	—	9	4	—	—	—	10	3	—	—	—	11	2	—	—	—	12	1	—	—	—	13	Internal Conn.	—	—	—	14	Internal Conn.	—	—	—	15	Internal Conn.	—	—	—	16	2	—	—	—	17	1	—	—	—
PIN NUMBER	CHARACTER																																																																																																																																																																																																																
1	Anode																																																																																																																																																																																																																
2	0																																																																																																																																																																																																																
3	8																																																																																																																																																																																																																
4	9																																																																																																																																																																																																																
5	6																																																																																																																																																																																																																
6	5																																																																																																																																																																																																																
7	4																																																																																																																																																																																																																
8	3																																																																																																																																																																																																																
9	2																																																																																																																																																																																																																
10	1																																																																																																																																																																																																																
11	Decimal Pt.																																																																																																																																																																																																																
12	Internal Conn.																																																																																																																																																																																																																
13	Internal Conn.																																																																																																																																																																																																																
14	Internal Conn.																																																																																																																																																																																																																
PIN NUMBER	CHARACTER	NL-6034	NL-5032	NL-5016	NL-50911 ONLY																																																																																																																																																																																																												
1	Internal Conn.	—	—	—	—																																																																																																																																																																																																												
2	Anode	—	—	—	—																																																																																																																																																																																																												
3	0	—	—	—	—																																																																																																																																																																																																												
4	8	—	—	—	—																																																																																																																																																																																																												
5	9	—	—	—	—																																																																																																																																																																																																												
6	6	—	—	—	—																																																																																																																																																																																																												
7	5	—	—	—	—																																																																																																																																																																																																												
8	4	—	—	—	—																																																																																																																																																																																																												
9	3	—	—	—	—																																																																																																																																																																																																												
10	2	—	—	—	—																																																																																																																																																																																																												
11	3	—	—	—	—																																																																																																																																																																																																												
12	2	—	—	—	—																																																																																																																																																																																																												
13	1	—	—	—	—																																																																																																																																																																																																												
PIN NUMBER	NL-8091	NL-7094	NL-887 ONLY	NL-825 ONLY																																																																																																																																																																																																													
1	Internal Conn.	—	—	—																																																																																																																																																																																																													
2	Anode	—	—	—																																																																																																																																																																																																													
3	0	—	—	—																																																																																																																																																																																																													
4	8	—	—	—																																																																																																																																																																																																													
5	9	—	—	—																																																																																																																																																																																																													
6	Internal Conn.	—	—	—																																																																																																																																																																																																													
7	6	—	—	—																																																																																																																																																																																																													
8	5	—	—	—																																																																																																																																																																																																													
9	4	—	—	—																																																																																																																																																																																																													
10	3	—	—	—																																																																																																																																																																																																													
11	2	—	—	—																																																																																																																																																																																																													
12	1	—	—	—																																																																																																																																																																																																													
13	Internal Conn.	—	—	—																																																																																																																																																																																																													
14	Internal Conn.	—	—	—																																																																																																																																																																																																													
15	Internal Conn.	—	—	—																																																																																																																																																																																																													
16	2	—	—	—																																																																																																																																																																																																													
17	1	—	—	—																																																																																																																																																																																																													

- Krypton gas filled tube with long leads (1.8" nominal).
- Non mercury version
- †Decimal point cathode current, max.-0.7 mA & min.-0.2 mA.

ELECTRONICS READOUT TUBES

NL-840, NL-844†	NL-900	NL-904	NL-874	NL-5445																																																																																																																																																																																																																																																																																																																															
NL-843, NL-847†	NL-903		NL-884																																																																																																																																																																																																																																																																																																																																
NL-841, NL-845†	NL-901	NL-905	NL-875																																																																																																																																																																																																																																																																																																																																
NL-842, NL-846†			NL-876																																																																																																																																																																																																																																																																																																																																
NL-848																																																																																																																																																																																																																																																																																																																																			
.610	.610	.610	.610	.610																																																																																																																																																																																																																																																																																																																															
30	30	30	30	30																																																																																																																																																																																																																																																																																																																															
† 170 Vdc 170 Vdc 170 Vdc 170 Vdc 3.5 mA 4.5 mA 3.0 mA 4.0 mA 1.5 mA 2.0 mA	170 Vdc 170 Vdc 3.5 mA 3.0 mA 1.5 mA	170 Vdc 170 Vdc 3.5 mA 3.0 mA 1.5 mA	170 Vdc 170 Vdc 3.5 mA 3.0 mA 1.5 mA	170 Vdc 170 Vdc 3.5 mA 3.0 mA 1.5 mA																																																																																																																																																																																																																																																																																																																															
50 Vdc to 120 Vdc	50 Vdc to 120 Vdc	50 Vdc to 120 Vdc	50 Vdc to 120 Vdc	50 Vdc to 120 Vdc																																																																																																																																																																																																																																																																																																																															
170Vdc 250Vdc 300Vdc 8.2K 39K 56K	170Vdc 250Vdc 300Vdc 8.2K 39K 56K	170Vdc 250Vdc 300Vdc 8.2K 39K 56K	170Vdc 250Vdc 300Vdc 8.2K 39K 56K	170Vdc 250Vdc 300Vdc 10K 39K 56K																																																																																																																																																																																																																																																																																																																															
-20°C to +55°C -40°C to +70°C 0.3 oz.	-20°C to +55°C -40°C to +70°C 0.3 oz.	-20°C to +55°C -40°C to +70°C 0.3 oz.	-20°C to +55°C -40°C to +70°C 0.3 oz.	-20°C to +55°C -40°C to +70°C 0.3 oz.																																																																																																																																																																																																																																																																																																																															
RTS-48, RTS-18	RTS-18	RTS-18	RTS-48, RTS-18	RTS-54																																																																																																																																																																																																																																																																																																																															
PINS 1 & 10 IN FRONT	PINS 1 & 10 IN FRONT	PINS 1 & 10 IN FRONT	PINS 1 & 10 IN FRONT	PINS 8 & 9 IN FRONT																																																																																																																																																																																																																																																																																																																															
<table border="1"> <thead> <tr> <th>PIN NUMBER</th> <th>840</th> <th>843</th> <th>842</th> <th>845</th> <th>846</th> <th>848</th> </tr> </thead> <tbody> <tr><td>1</td><td>—</td><td>—</td><td>—</td><td>—</td><td>—</td><td>—</td></tr> <tr><td>2</td><td>—</td><td>—</td><td>—</td><td>—</td><td>—</td><td>—</td></tr> <tr><td>3</td><td>—</td><td>—</td><td>—</td><td>—</td><td>—</td><td>—</td></tr> <tr><td>4</td><td>—</td><td>—</td><td>—</td><td>—</td><td>—</td><td>—</td></tr> <tr><td>5</td><td>—</td><td>—</td><td>—</td><td>—</td><td>—</td><td>—</td></tr> <tr><td>6</td><td>—</td><td>—</td><td>—</td><td>—</td><td>—</td><td>—</td></tr> <tr><td>7</td><td>—</td><td>—</td><td>—</td><td>—</td><td>—</td><td>—</td></tr> <tr><td>8</td><td>—</td><td>—</td><td>—</td><td>—</td><td>—</td><td>—</td></tr> <tr><td>9</td><td>—</td><td>—</td><td>—</td><td>—</td><td>—</td><td>—</td></tr> <tr><td>10</td><td>—</td><td>—</td><td>—</td><td>—</td><td>—</td><td>—</td></tr> <tr><td>11</td><td>—</td><td>—</td><td>—</td><td>—</td><td>—</td><td>—</td></tr> <tr><td>12</td><td>—</td><td>—</td><td>—</td><td>—</td><td>—</td><td>—</td></tr> <tr><td>13</td><td>—</td><td>—</td><td>—</td><td>—</td><td>—</td><td>—</td></tr> <tr><td>14</td><td>—</td><td>—</td><td>—</td><td>—</td><td>—</td><td>—</td></tr> </tbody> </table>	PIN NUMBER	840	843	842	845	846	848	1	—	—	—	—	—	—	2	—	—	—	—	—	—	3	—	—	—	—	—	—	4	—	—	—	—	—	—	5	—	—	—	—	—	—	6	—	—	—	—	—	—	7	—	—	—	—	—	—	8	—	—	—	—	—	—	9	—	—	—	—	—	—	10	—	—	—	—	—	—	11	—	—	—	—	—	—	12	—	—	—	—	—	—	13	—	—	—	—	—	—	14	—	—	—	—	—	—	<table border="1"> <thead> <tr> <th>PIN NO.</th> <th>900</th> <th>903</th> <th>901</th> </tr> </thead> <tbody> <tr><td>1</td><td>7</td><td>—</td><td>7</td></tr> <tr><td>2</td><td>5</td><td>—</td><td>5</td></tr> <tr><td>3</td><td>8</td><td>—</td><td>8</td></tr> <tr><td>4</td><td>Anode</td><td>Anode</td><td>Anode</td></tr> <tr><td>5</td><td>1</td><td>—</td><td>1</td></tr> <tr><td>6</td><td>4</td><td>—</td><td>4</td></tr> <tr><td>7</td><td>2</td><td>—</td><td>2</td></tr> <tr><td>8</td><td>6</td><td>—</td><td>6</td></tr> <tr><td>9</td><td>9</td><td>—</td><td>9</td></tr> <tr><td>10</td><td>3</td><td>—</td><td>3</td></tr> <tr><td>11</td><td>I.C.</td><td>—</td><td>Dec.</td></tr> <tr><td>12</td><td>No Pin</td><td>No Pin</td><td>No Pin</td></tr> <tr><td>13</td><td>0</td><td>—</td><td>0</td></tr> <tr><td>14</td><td>I.C.</td><td>I.C.</td><td>I.C.</td></tr> </tbody> </table>	PIN NO.	900	903	901	1	7	—	7	2	5	—	5	3	8	—	8	4	Anode	Anode	Anode	5	1	—	1	6	4	—	4	7	2	—	2	8	6	—	6	9	9	—	9	10	3	—	3	11	I.C.	—	Dec.	12	No Pin	No Pin	No Pin	13	0	—	0	14	I.C.	I.C.	I.C.	<table border="1"> <thead> <tr> <th>PIN NO.</th> <th>904</th> <th>905</th> </tr> </thead> <tbody> <tr><td>1</td><td>7</td><td>7</td></tr> <tr><td>2</td><td>5</td><td>5</td></tr> <tr><td>3</td><td>8</td><td>8</td></tr> <tr><td>4</td><td>Anode</td><td>Anode</td></tr> <tr><td>5</td><td>1</td><td>1</td></tr> <tr><td>6</td><td>4</td><td>4</td></tr> <tr><td>7</td><td>2</td><td>2</td></tr> <tr><td>8</td><td>6</td><td>6</td></tr> <tr><td>9</td><td>9</td><td>9</td></tr> <tr><td>10</td><td>3</td><td>3</td></tr> <tr><td>11</td><td>I.C.</td><td>Dec.</td></tr> <tr><td>12</td><td>No Pin</td><td>No Pin</td></tr> <tr><td>13</td><td>0</td><td>0</td></tr> <tr><td>14</td><td>I.C.</td><td>I.C.</td></tr> </tbody> </table>	PIN NO.	904	905	1	7	7	2	5	5	3	8	8	4	Anode	Anode	5	1	1	6	4	4	7	2	2	8	6	6	9	9	9	10	3	3	11	I.C.	Dec.	12	No Pin	No Pin	13	0	0	14	I.C.	I.C.	<table border="1"> <thead> <tr> <th>PIN NUMBER</th> <th>NL-874</th> <th>NL-875</th> <th>NL-876</th> <th>NL-884</th> </tr> </thead> <tbody> <tr><td>1</td><td>7</td><td>7</td><td>—</td><td>—</td></tr> <tr><td>2</td><td>5</td><td>5</td><td>—</td><td>—</td></tr> <tr><td>3</td><td>8</td><td>8</td><td>—</td><td>—</td></tr> <tr><td>4</td><td>Anode</td><td>Anode</td><td>Anode</td><td>—</td></tr> <tr><td>5</td><td>1</td><td>1</td><td>—</td><td>—</td></tr> <tr><td>6</td><td>4</td><td>4</td><td>—</td><td>—</td></tr> <tr><td>7</td><td>2</td><td>2</td><td>—</td><td>—</td></tr> <tr><td>8</td><td>6</td><td>6</td><td>—</td><td>—</td></tr> <tr><td>9</td><td>9</td><td>9</td><td>—</td><td>—</td></tr> <tr><td>10</td><td>3</td><td>3</td><td>—</td><td>—</td></tr> <tr><td>11</td><td>Int. Conn.</td><td>Decimal Pt.</td><td>No Conn.</td><td>—</td></tr> <tr><td>12</td><td>No Pin</td><td>No Pin</td><td>No Pin</td><td>—</td></tr> <tr><td>13</td><td>0</td><td>0</td><td>Int. Conn.</td><td>—</td></tr> <tr><td>14</td><td>Int. Conn.</td><td>Int. Conn.</td><td>Int. Conn.</td><td>—</td></tr> </tbody> </table>	PIN NUMBER	NL-874	NL-875	NL-876	NL-884	1	7	7	—	—	2	5	5	—	—	3	8	8	—	—	4	Anode	Anode	Anode	—	5	1	1	—	—	6	4	4	—	—	7	2	2	—	—	8	6	6	—	—	9	9	9	—	—	10	3	3	—	—	11	Int. Conn.	Decimal Pt.	No Conn.	—	12	No Pin	No Pin	No Pin	—	13	0	0	Int. Conn.	—	14	Int. Conn.	Int. Conn.	Int. Conn.	—	<table border="1"> <thead> <tr> <th>PIN NO.</th> <th>5445</th> </tr> </thead> <tbody> <tr><td>1</td><td>Anode</td></tr> <tr><td>2</td><td>1</td></tr> <tr><td>3</td><td>2</td></tr> <tr><td>4</td><td>9</td></tr> <tr><td>5</td><td>7</td></tr> <tr><td>6</td><td>I.C.</td></tr> <tr><td>7</td><td>8</td></tr> <tr><td>8</td><td>I.C.</td></tr> <tr><td>9</td><td>3</td></tr> <tr><td>10</td><td>4</td></tr> <tr><td>11</td><td>I.C.</td></tr> <tr><td>12</td><td>5</td></tr> <tr><td>13</td><td>6</td></tr> <tr><td>14</td><td>0</td></tr> <tr><td>15</td><td>I.C.</td></tr> <tr><td>16</td><td>I.C.</td></tr> </tbody> </table>	PIN NO.	5445	1	Anode	2	1	3	2	4	9	5	7	6	I.C.	7	8	8	I.C.	9	3	10	4	11	I.C.	12	5	13	6	14	0	15	I.C.	16	I.C.
PIN NUMBER	840	843	842	845	846	848																																																																																																																																																																																																																																																																																																																													
1	—	—	—	—	—	—																																																																																																																																																																																																																																																																																																																													
2	—	—	—	—	—	—																																																																																																																																																																																																																																																																																																																													
3	—	—	—	—	—	—																																																																																																																																																																																																																																																																																																																													
4	—	—	—	—	—	—																																																																																																																																																																																																																																																																																																																													
5	—	—	—	—	—	—																																																																																																																																																																																																																																																																																																																													
6	—	—	—	—	—	—																																																																																																																																																																																																																																																																																																																													
7	—	—	—	—	—	—																																																																																																																																																																																																																																																																																																																													
8	—	—	—	—	—	—																																																																																																																																																																																																																																																																																																																													
9	—	—	—	—	—	—																																																																																																																																																																																																																																																																																																																													
10	—	—	—	—	—	—																																																																																																																																																																																																																																																																																																																													
11	—	—	—	—	—	—																																																																																																																																																																																																																																																																																																																													
12	—	—	—	—	—	—																																																																																																																																																																																																																																																																																																																													
13	—	—	—	—	—	—																																																																																																																																																																																																																																																																																																																													
14	—	—	—	—	—	—																																																																																																																																																																																																																																																																																																																													
PIN NO.	900	903	901																																																																																																																																																																																																																																																																																																																																
1	7	—	7																																																																																																																																																																																																																																																																																																																																
2	5	—	5																																																																																																																																																																																																																																																																																																																																
3	8	—	8																																																																																																																																																																																																																																																																																																																																
4	Anode	Anode	Anode																																																																																																																																																																																																																																																																																																																																
5	1	—	1																																																																																																																																																																																																																																																																																																																																
6	4	—	4																																																																																																																																																																																																																																																																																																																																
7	2	—	2																																																																																																																																																																																																																																																																																																																																
8	6	—	6																																																																																																																																																																																																																																																																																																																																
9	9	—	9																																																																																																																																																																																																																																																																																																																																
10	3	—	3																																																																																																																																																																																																																																																																																																																																
11	I.C.	—	Dec.																																																																																																																																																																																																																																																																																																																																
12	No Pin	No Pin	No Pin																																																																																																																																																																																																																																																																																																																																
13	0	—	0																																																																																																																																																																																																																																																																																																																																
14	I.C.	I.C.	I.C.																																																																																																																																																																																																																																																																																																																																
PIN NO.	904	905																																																																																																																																																																																																																																																																																																																																	
1	7	7																																																																																																																																																																																																																																																																																																																																	
2	5	5																																																																																																																																																																																																																																																																																																																																	
3	8	8																																																																																																																																																																																																																																																																																																																																	
4	Anode	Anode																																																																																																																																																																																																																																																																																																																																	
5	1	1																																																																																																																																																																																																																																																																																																																																	
6	4	4																																																																																																																																																																																																																																																																																																																																	
7	2	2																																																																																																																																																																																																																																																																																																																																	
8	6	6																																																																																																																																																																																																																																																																																																																																	
9	9	9																																																																																																																																																																																																																																																																																																																																	
10	3	3																																																																																																																																																																																																																																																																																																																																	
11	I.C.	Dec.																																																																																																																																																																																																																																																																																																																																	
12	No Pin	No Pin																																																																																																																																																																																																																																																																																																																																	
13	0	0																																																																																																																																																																																																																																																																																																																																	
14	I.C.	I.C.																																																																																																																																																																																																																																																																																																																																	
PIN NUMBER	NL-874	NL-875	NL-876	NL-884																																																																																																																																																																																																																																																																																																																															
1	7	7	—	—																																																																																																																																																																																																																																																																																																																															
2	5	5	—	—																																																																																																																																																																																																																																																																																																																															
3	8	8	—	—																																																																																																																																																																																																																																																																																																																															
4	Anode	Anode	Anode	—																																																																																																																																																																																																																																																																																																																															
5	1	1	—	—																																																																																																																																																																																																																																																																																																																															
6	4	4	—	—																																																																																																																																																																																																																																																																																																																															
7	2	2	—	—																																																																																																																																																																																																																																																																																																																															
8	6	6	—	—																																																																																																																																																																																																																																																																																																																															
9	9	9	—	—																																																																																																																																																																																																																																																																																																																															
10	3	3	—	—																																																																																																																																																																																																																																																																																																																															
11	Int. Conn.	Decimal Pt.	No Conn.	—																																																																																																																																																																																																																																																																																																																															
12	No Pin	No Pin	No Pin	—																																																																																																																																																																																																																																																																																																																															
13	0	0	Int. Conn.	—																																																																																																																																																																																																																																																																																																																															
14	Int. Conn.	Int. Conn.	Int. Conn.	—																																																																																																																																																																																																																																																																																																																															
PIN NO.	5445																																																																																																																																																																																																																																																																																																																																		
1	Anode																																																																																																																																																																																																																																																																																																																																		
2	1																																																																																																																																																																																																																																																																																																																																		
3	2																																																																																																																																																																																																																																																																																																																																		
4	9																																																																																																																																																																																																																																																																																																																																		
5	7																																																																																																																																																																																																																																																																																																																																		
6	I.C.																																																																																																																																																																																																																																																																																																																																		
7	8																																																																																																																																																																																																																																																																																																																																		
8	I.C.																																																																																																																																																																																																																																																																																																																																		
9	3																																																																																																																																																																																																																																																																																																																																		
10	4																																																																																																																																																																																																																																																																																																																																		
11	I.C.																																																																																																																																																																																																																																																																																																																																		
12	5																																																																																																																																																																																																																																																																																																																																		
13	6																																																																																																																																																																																																																																																																																																																																		
14	0																																																																																																																																																																																																																																																																																																																																		
15	I.C.																																																																																																																																																																																																																																																																																																																																		
16	I.C.																																																																																																																																																																																																																																																																																																																																		

†High contrast tubes. Anode resistor (Rp) 7K-170Vdc, 33K-250Vdc, 50K-300Vdc.

■NL-5870 and NL-5870L also available. Lead length 1.6" nom. measured from bottom end of stand off.

†Pads supplied with these tubes may be damaged by chlorinated hydrocarbons.

TECHNICAL DATA NATIONAL ELECTRONICS READOUT TUBES

NUMERALS 0 thru 9	NL-5025		NL-807			NL-7037																																																																																																																																																																																			
SYMBOLS + and -						NL-863																																																																																																																																																																																			
LT HAND DECIMAL						NL-821																																																																																																																																																																																			
SPECIAL CHARACTER	NL-5094		NL-5971																																																																																																																																																																																						
CHARACTER SIZE (INCHES)	.310		.610		.625			.808		2																																																																																																																																																																															
VIEWING DISTANCE (FEET)	14		30		25			38		100																																																																																																																																																																															
ELECTRICAL RATINGS AND CHARACTERISTICS	Ionization Voltage (Maximum)		170 Vdc		170 Vdc			170 Vdc		200 Vdc																																																																																																																																																																															
	Supply Voltage (Minimum)		170 Vdc		170 Vdc			170 Vdc		200 Vdc																																																																																																																																																																															
	Cathode Current - Peak (Max.)		2.5 mA		12 mA			5.0 mA		10 mA																																																																																																																																																																															
	Average (Max.)		2.0 mA		4.5 mA			4.5 mA		10 mA																																																																																																																																																																															
	Average (Min.)		0.75 mA		—			2.0 mA		6 mA																																																																																																																																																																															
dc Prebias Voltage Limits...	65 Vdc to 120 Vdc		40 Vdc to 70 Vdc		—			50 Vdc to 120 Vdc		65 Vdc to 120 Vdc																																																																																																																																																																															
**Recommended Operating Conditions	170Vdc 250Vdc 300Vdc		150 Vdc 200 Vdc		170 Vdc			170Vdc 250Vdc 300Vdc		200Vdc 250Vdc 300Vdc																																																																																																																																																																															
Corresponding Anode Resistor (Rp)	15K 82K 130K		18K 36K		6.8K			6.8K 30K 43K		8.2K 15K 20K																																																																																																																																																																															
Temperature Limits (Reduced Life)	-20 °C to +55 °C -40 °C to +70 °C		-65 °C to +70 °C		-20 °C to +55 °C -65 °C to +85 °C			-20 °C to +55 °C -40 °C to +70 °C		-20 °C to +55 °C -40 °C to +70 °C																																																																																																																																																																															
Weight	0.4 oz.		0.6 oz.					0.5 oz.		3 oz.																																																																																																																																																																															
OUTLINE DRAWINGS																																																																																																																																																																																									
Socket (See Page 12)	RTS-1, RTS-2		C.F.		RTS-58 RTS-59			RTS-48, RTS-18		RTS-5																																																																																																																																																																															
Mounting Position	PINS 1-8 VERTICALLY ALIGNED WITH PIN 8 ON TOP		—		PINS 6 & 12 VERTICALLY ALIGNED WITH PIN 12 ON TOP			PINS 1 & 10 IN FRONT		PINS 1 & 10 ALIGNED VIEWING DIRECTION WITH PIN 1 IN FRONT																																																																																																																																																																															
PIN CONNECTIONS	<table border="1" style="font-size: small;"> <tr><th>PIN NUMBER</th><th>CHARACTER</th></tr> <tr><td>1</td><td>No Conn.</td></tr> <tr><td>2</td><td>Anode</td></tr> <tr><td>3</td><td>A</td></tr> <tr><td>4</td><td>No Conn.</td></tr> <tr><td>5</td><td>S</td></tr> <tr><td>6</td><td>No Conn.</td></tr> <tr><td>7</td><td>V</td></tr> <tr><td>8</td><td>No Conn.</td></tr> <tr><td>9</td><td>M</td></tr> <tr><td>10</td><td>No Conn.</td></tr> <tr><td>11</td><td>N</td></tr> <tr><td>12</td><td>No Conn.</td></tr> <tr><td>13</td><td>U</td></tr> </table>		PIN NUMBER	CHARACTER	1	No Conn.	2	Anode	3	A	4	No Conn.	5	S	6	No Conn.	7	V	8	No Conn.	9	M	10	No Conn.	11	N	12	No Conn.	13	U	<table border="1" style="font-size: small;"> <tr><th>PIN NUMBER</th><th>CHARACTER</th></tr> <tr><td>1</td><td>Internal Conn.</td></tr> <tr><td>2</td><td>Even Anode</td></tr> <tr><td>3</td><td>8-9</td></tr> <tr><td>4</td><td>5-7</td></tr> <tr><td>5</td><td>4-5</td></tr> <tr><td>6</td><td>Screen</td></tr> <tr><td>7</td><td>2-3</td></tr> <tr><td>8</td><td>0-1</td></tr> <tr><td>9</td><td>Odd Anode</td></tr> </table> <p style="font-size: small; margin-top: 10px;"><i>TYPICAL BI QUINARY 9 PIN TUBE</i></p>		PIN NUMBER	CHARACTER	1	Internal Conn.	2	Even Anode	3	8-9	4	5-7	5	4-5	6	Screen	7	2-3	8	0-1	9	Odd Anode	<table border="1" style="font-size: small;"> <tr><th>PIN NUMBER</th><th>CHARACTER</th></tr> <tr><td>1</td><td>Anode</td></tr> <tr><td>2</td><td>Cathode 8</td></tr> <tr><td>3</td><td>Cathode 19</td></tr> <tr><td>4</td><td>Cathode 5</td></tr> <tr><td>5</td><td>Cathode 12</td></tr> <tr><td>6</td><td>Cathode 4</td></tr> <tr><td>7</td><td>Cathode 11</td></tr> <tr><td>8</td><td>Cathode 3</td></tr> <tr><td>9</td><td>Cathode 10</td></tr> <tr><td>10</td><td>Cathode 2</td></tr> <tr><td>11</td><td>Cathode 9</td></tr> <tr><td>12</td><td>Cathode 1</td></tr> <tr><td>13</td><td>Cathode 7</td></tr> <tr><td>14</td><td>Cathode 8</td></tr> </table>			PIN NUMBER	CHARACTER	1	Anode	2	Cathode 8	3	Cathode 19	4	Cathode 5	5	Cathode 12	6	Cathode 4	7	Cathode 11	8	Cathode 3	9	Cathode 10	10	Cathode 2	11	Cathode 9	12	Cathode 1	13	Cathode 7	14	Cathode 8	<table border="1" style="font-size: small;"> <tr><th>PIN NUMBER</th><th>CHARACTER</th><th>NL-821</th></tr> <tr><td>2</td><td>7</td><td>7</td></tr> <tr><td>3</td><td>5</td><td>5</td></tr> <tr><td>4</td><td>8</td><td>8</td></tr> <tr><td>5</td><td>Anode</td><td>Anode</td></tr> <tr><td>6</td><td>1</td><td>4</td></tr> <tr><td>7</td><td>2</td><td>2</td></tr> <tr><td>8</td><td>6</td><td>6</td></tr> <tr><td>9</td><td>9</td><td>9</td></tr> <tr><td>10</td><td>3</td><td>3</td></tr> <tr><td>11</td><td>No Pin</td><td>Dec. Pt.</td></tr> <tr><td>12</td><td>No Pin</td><td>No Pin</td></tr> <tr><td>13</td><td>0</td><td>0</td></tr> <tr><td>14</td><td>Internal Conn.</td><td>Internal Conn.</td></tr> </table>		PIN NUMBER	CHARACTER	NL-821	2	7	7	3	5	5	4	8	8	5	Anode	Anode	6	1	4	7	2	2	8	6	6	9	9	9	10	3	3	11	No Pin	Dec. Pt.	12	No Pin	No Pin	13	0	0	14	Internal Conn.	Internal Conn.	<table border="1" style="font-size: small;"> <tr><th>PIN NUMBER</th><th>7037</th><th>863</th></tr> <tr><td>1</td><td>Internal Conn.</td><td>I.C.</td></tr> <tr><td>2</td><td>Anode</td><td>Anode Plus</td></tr> <tr><td>3</td><td>0</td><td>0</td></tr> <tr><td>4</td><td>0</td><td>0</td></tr> <tr><td>5</td><td>Internal Conn.</td><td>I.C.</td></tr> <tr><td>6</td><td>Internal Conn.</td><td>I.C.</td></tr> <tr><td>7</td><td>2</td><td>—</td></tr> <tr><td>8</td><td>4</td><td>—</td></tr> <tr><td>9</td><td>1</td><td>—</td></tr> <tr><td>10</td><td>Internal Conn.</td><td>—</td></tr> <tr><td>11</td><td>Internal Conn.</td><td>—</td></tr> <tr><td>12</td><td>8</td><td>—</td></tr> <tr><td>13</td><td>9</td><td>—</td></tr> <tr><td>14</td><td>5</td><td>—</td></tr> <tr><td>15</td><td>Internal Conn.</td><td>I.C.</td></tr> <tr><td>16</td><td>7</td><td>—</td></tr> <tr><td>17</td><td>3</td><td>—</td></tr> </table>		PIN NUMBER	7037	863	1	Internal Conn.	I.C.	2	Anode	Anode Plus	3	0	0	4	0	0	5	Internal Conn.	I.C.	6	Internal Conn.	I.C.	7	2	—	8	4	—	9	1	—	10	Internal Conn.	—	11	Internal Conn.	—	12	8	—	13	9	—	14	5	—	15	Internal Conn.	I.C.	16	7	—	17	3	—
PIN NUMBER	CHARACTER																																																																																																																																																																																								
1	No Conn.																																																																																																																																																																																								
2	Anode																																																																																																																																																																																								
3	A																																																																																																																																																																																								
4	No Conn.																																																																																																																																																																																								
5	S																																																																																																																																																																																								
6	No Conn.																																																																																																																																																																																								
7	V																																																																																																																																																																																								
8	No Conn.																																																																																																																																																																																								
9	M																																																																																																																																																																																								
10	No Conn.																																																																																																																																																																																								
11	N																																																																																																																																																																																								
12	No Conn.																																																																																																																																																																																								
13	U																																																																																																																																																																																								
PIN NUMBER	CHARACTER																																																																																																																																																																																								
1	Internal Conn.																																																																																																																																																																																								
2	Even Anode																																																																																																																																																																																								
3	8-9																																																																																																																																																																																								
4	5-7																																																																																																																																																																																								
5	4-5																																																																																																																																																																																								
6	Screen																																																																																																																																																																																								
7	2-3																																																																																																																																																																																								
8	0-1																																																																																																																																																																																								
9	Odd Anode																																																																																																																																																																																								
PIN NUMBER	CHARACTER																																																																																																																																																																																								
1	Anode																																																																																																																																																																																								
2	Cathode 8																																																																																																																																																																																								
3	Cathode 19																																																																																																																																																																																								
4	Cathode 5																																																																																																																																																																																								
5	Cathode 12																																																																																																																																																																																								
6	Cathode 4																																																																																																																																																																																								
7	Cathode 11																																																																																																																																																																																								
8	Cathode 3																																																																																																																																																																																								
9	Cathode 10																																																																																																																																																																																								
10	Cathode 2																																																																																																																																																																																								
11	Cathode 9																																																																																																																																																																																								
12	Cathode 1																																																																																																																																																																																								
13	Cathode 7																																																																																																																																																																																								
14	Cathode 8																																																																																																																																																																																								
PIN NUMBER	CHARACTER	NL-821																																																																																																																																																																																							
2	7	7																																																																																																																																																																																							
3	5	5																																																																																																																																																																																							
4	8	8																																																																																																																																																																																							
5	Anode	Anode																																																																																																																																																																																							
6	1	4																																																																																																																																																																																							
7	2	2																																																																																																																																																																																							
8	6	6																																																																																																																																																																																							
9	9	9																																																																																																																																																																																							
10	3	3																																																																																																																																																																																							
11	No Pin	Dec. Pt.																																																																																																																																																																																							
12	No Pin	No Pin																																																																																																																																																																																							
13	0	0																																																																																																																																																																																							
14	Internal Conn.	Internal Conn.																																																																																																																																																																																							
PIN NUMBER	7037	863																																																																																																																																																																																							
1	Internal Conn.	I.C.																																																																																																																																																																																							
2	Anode	Anode Plus																																																																																																																																																																																							
3	0	0																																																																																																																																																																																							
4	0	0																																																																																																																																																																																							
5	Internal Conn.	I.C.																																																																																																																																																																																							
6	Internal Conn.	I.C.																																																																																																																																																																																							
7	2	—																																																																																																																																																																																							
8	4	—																																																																																																																																																																																							
9	1	—																																																																																																																																																																																							
10	Internal Conn.	—																																																																																																																																																																																							
11	Internal Conn.	—																																																																																																																																																																																							
12	8	—																																																																																																																																																																																							
13	9	—																																																																																																																																																																																							
14	5	—																																																																																																																																																																																							
15	Internal Conn.	I.C.																																																																																																																																																																																							
16	7	—																																																																																																																																																																																							
17	3	—																																																																																																																																																																																							

*Other characters available by special order.

**See Fig. 1 & 3, Page 9. Use of the highest voltage available with the appropriate resistor is recommended.

RATINGS, CHARACTERISTICS AND APPLICATIONS NOTES

GENERAL

A National Readout Tube is basically a gas filled, cold cathode diode with multiple cathodes. Each cathode is shaped like a display character and has a separate base pin electrical connection. Negative voltage (with respect to anode) applied to the selected character base pin causes the shaped glow discharge.

Readout Tube operation can be explained more fully by considering the tube similar to a single cathode gas diode. Fig. 1 shows a simple operating circuit with the Readout Tube

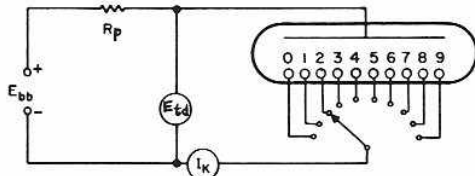

FIG. 1. READOUT TUBE FUNDAMENTAL CIRCUIT

diode connected as in normal use. By varying circuit parameters, we can obtain a typical plot (Fig. 2) of tube voltage, E_{td} , versus cathode current, I_k . Increasing E_b from zero to the ionization voltage causes only a small increase in I_k and no glow. At ionization voltage, a glow appears. With increasing I_k , two glow regions are reached; normal and abnormal. For clarity in this discussion, the high current end of abnormal glow is called intense glow. Normal glow illuminates only partial characters so is not satisfactory; intense glow operation may shorten tube life and cause extraneous lighting. Desired operation is obtained in the abnormal glow region and is the operating condition specified in technical data sheets.

ELECTRICAL RATINGS AND CHARACTERISTICS

Supply Voltage, E_{bb} (Minimum)

Minimum Supply Voltage must always equal or exceed Maximum Ionization Voltage for proper tube operation. This is a necessary condition to make sure that all tubes will ionize and operate within rated current limits. How Supply Voltage in conjunction with anode resistance determines cathode current is explained under Recommended Operating Conditions.

Cathode Current, I_k — Peak (Maximum)

Cathode Current, as shown in Fig. 2, determines in which glow region the tube operates. Maximum Peak Cathode Current places operation at the higher end of abnormal glow approaching the region of intense glow with attendant possibilities of extraneous lighting.

The NL5870S and NL5870ST were designed to operate with a very high maximum peak current for pulse or strobe applications.

Cathode Current, I_k — Average (Maximum and Minimum)

Again referring to Fig. 2, maximum and minimum limits of cathode current keep tube operation within the abnormal glow region giving the best display consistent with long life. Optimum current is midway between maximum and minimum.

In Pulse or Strobe application using high peak current the duty cycle must be limited to keep the average cathode current within the recommended limits. Average cathode currents higher than the recommended maximum can cause excessive sputtering of cathode material, overheating and reduced life.

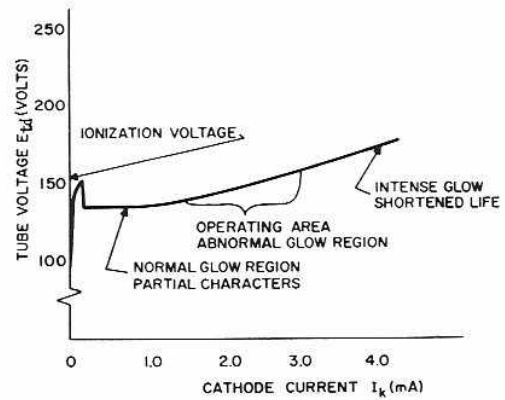

FIG. 2. NL-8422 TYPICAL VOLT-AMPERE CHARACTERISTIC

Recommended Operating Conditions

Various Supply Voltages (E_{bb}) are given with corresponding values of anode resistor (R_p) for proper operation. These values are obtained from an electrical characteristic curve, Fig. 3. The NL-8422 is used as an example; other tube types have similar curves. Two parallel lines show characteristic limits for all tubes of one type. Load lines are drawn for different values of R_p by first selecting a supply voltage, for example, 170 volts. A line drawn from this voltage on the ordinate through the intersection of mean I_k and a point midway between the parallel characteristic limits, has a slope representing proper R_p , in this case, 8.2K ohms. By identical steps, R_p is found for each E_{bb} of interest.

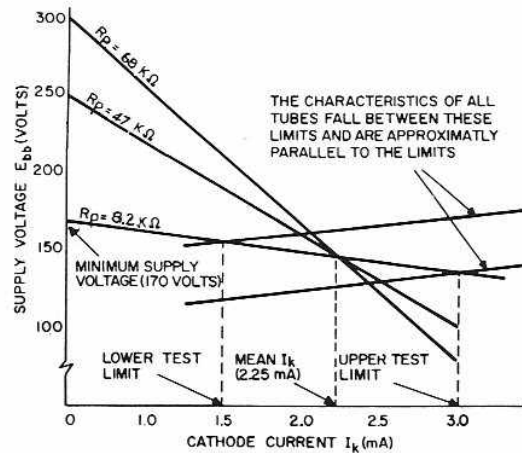

FIG. 3. ELECTRICAL CHARACTERISTICS

All tubes in circuits with a particular load line will operate on that line somewhere between the parallel characteristic limits. For example, at E_{bb} of 170 volts and R_p of 8.2K ohms, all tubes will operate between 1.5 ma (lower test limit) and 3.0 ma (upper test limit). Each load has a different length between the parallel characteristic limits. This means that cathode current extremes are different for each load line.

The average current and the corresponding tube drop are listed below:

Tube Type	E _{td} Volts (Avg.)	I _k ma (Avg.)	Tube Type	E _{td} Volts (Avg.)	I _k ma (Avg.)
NL-807	145	3.7	NL-5440A	143	2.6
NL-809	147	2.8	NL-5560	143	1.35
NL-840	150	2.5	NL-7037	136	7.8
NL-900	149	2.6	NL-7094	144	6.2
NL-904	149	2.6	NL-7977/4032	155	0.9
NL-5870S	134	3.5	NL-8421/5092	148	2.2
NL-5870ST	134	3.5	NL-8422/5991	150	2.5
NL-4998	155	1.0	NL-8423/6091	145	3.7
NL-5440	143	2.6	NL-8502/4021	99	1.05

NATIONAL ELECTRONICS CANNOT ASSUME RESPONSIBILITY FOR THE CIRCUITS SHOWN OR REPRESENT THAT THEY ARE FREE FROM PATENT INFRINGEMENT.

NATIONAL® READOUT TUBE BEZEL ASSEMBLIES

NATIONAL® READOUT TUBE BEZELS are designed to give maximum display effectiveness. The readout tubes are mounted in an enclosure finished dull black to minimize reflections. The amber circular polarized filter further reduces reflections and improves contrast and readability. Bezel assembly includes appropriate readout tube sockets and Polaroid filter type HACP-24.

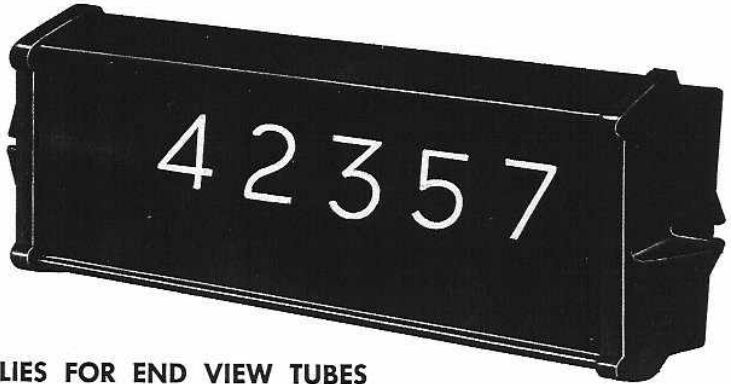

BEZEL ASSEMBLIES FOR END VIEW TUBES

Basic
Type Number

Description

- NL-BEZ-40** For All Miniature End View Types such as NL-7009, NL-7977/4032, and NL-8502/4021.
- NL-BEZ-50** For All Standard End View Types such as NL-6844A, NL-8037/5031, and NL-8421/5092.
- NL-BEZ-59** For All Standard Rectangular Types such as NL-809, and NL-8422/5991.
- NL-BEZ-60** For All Super End View Types such as NL-7153 and NL-8423/6091.

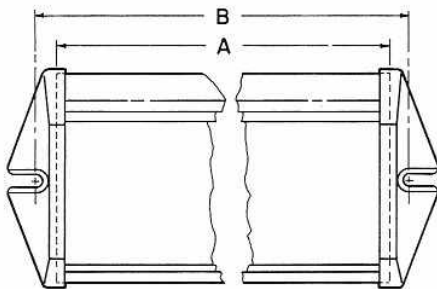

Assembly

NUMBER OF SOCKETS	BEZ-40		BEZ-50		BEZ-59		BEZ-60	
	A	B	A	B	A	B	A	B
2	3.125	3.425	4.125	4.425	3.325	3.625	4.125	4.425
3	3.875	4.175	5.312	5.612	4.125	4.425	5.625	5.925
4	4.625	4.925	6.500	6.800	4.925	5.225	7.125	7.425
5	5.375	5.675	7.687	7.987	5.725	6.025	8.625	8.925
6	6.125	6.425	8.875	9.175	6.525	6.825	10.125	10.425
7	6.875	7.175	10.062	10.362	7.325	7.625	11.625	11.925
8	7.625	7.925	11.250	11.550	8.125	8.425	13.125	13.425
9	8.375	8.675	12.437	12.737	8.925	9.225	14.625	14.925
10	9.125	9.425	13.625	13.925	9.725	10.025	16.125	16.425
11	9.874	10.174	14.806	15.106	10.524	10.824	17.624	17.924
12	10.624	10.924	15.993	16.293	11.324	11.624	19.124	19.424
13	11.374	11.674	17.180	17.480	12.124	12.424	20.624	20.924
14	12.124	12.424	18.367	18.667	12.924	13.224	22.124	22.424
15	12.874	13.174	19.554	19.854	13.724	14.024	23.624	23.924

Dimensions (inches)

Socket Spacing (Center to Center)

- NL-BEZ-400.750"
- NL-BEZ-501.187"
- NL-BEZ-590.800"
- NL-BEZ-601.500"

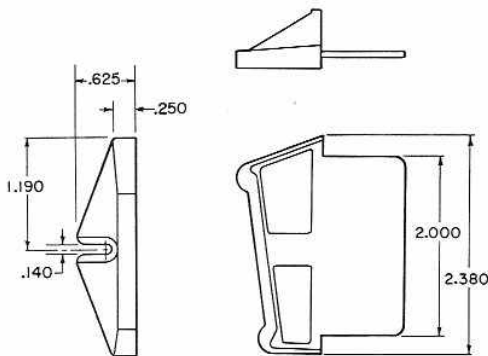

End Plate

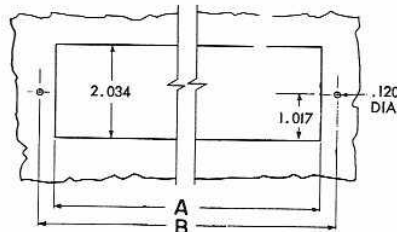

Customer Panel Cutout

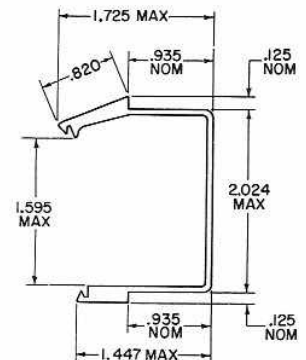

Extrusion

BEZEL ASSEMBLIES FOR SIDE VIEW TUBES

NL-BEZ-84 For Standard Side View Types (.750" dia.) such as NL-840.

NUMBER OF SOCKETS	A	B	C	D	E WITH FRAME	E WITHOUT FRAME	F WITH FRAME	F WITHOUT FRAME
2	3.700	3.020	2.800	3.300	2.820	2.550	1.260	1.230
3	4.500	3.820	3.600	4.100	3.620	3.350	1.260	1.230
4	5.300	4.620	4.400	4.900	4.420	4.150	1.260	1.230
5	6.100	5.420	5.200	5.700	5.220	4.950	1.260	1.230
6	6.900	6.220	6.000	6.500	6.020	5.750	1.260	1.230
7	7.700	7.020	6.800	7.300	6.820	6.550	1.260	1.230
8	8.500	7.820	7.600	8.100	7.620	7.350	1.260	1.230
9	9.300	8.620	8.400	8.900	8.420	8.150	1.260	1.230
10	10.100	9.420	9.200	9.700	9.220	8.950	1.260	1.230
11	10.900	10.220	10.000	10.500	10.020	9.750	1.260	1.230
12	11.700	11.020	10.800	11.300	10.820	10.550	1.260	1.230
13	12.500	11.820	11.600	12.100	11.620	11.350	1.260	1.230
14	13.300	12.620	12.400	12.900	12.420	12.150	1.260	1.230
15	14.100	13.420	13.200	13.700	13.220	12.950	1.260	1.230

Dimensions (inches)

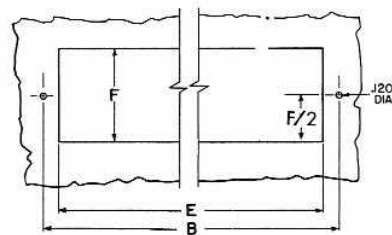
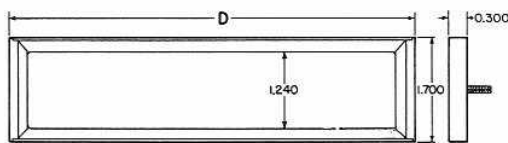
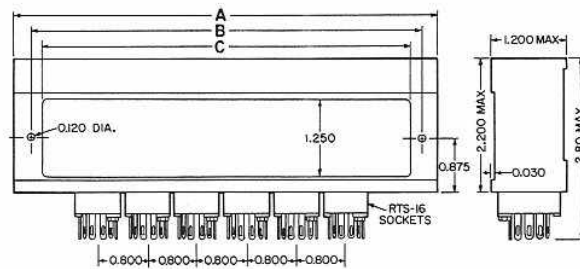
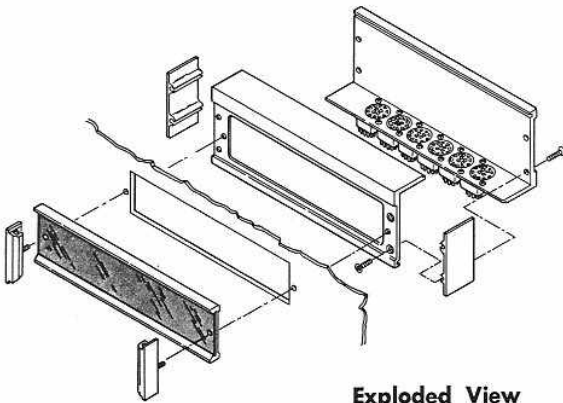

ORDERING INFORMATION

The complete type number consists of the five-letter two-digit basic type number followed by a second dash number representing the number of sockets required. Any modification of the standard bezel assembly will be considered a special and must be completely described; e.g. if decimal points are required the number and location must be specified. When special bezel assemblies are ordered, National will assign and add a special dash number to the standard type number. This special type number can be used for all reorders. For example:

